

Name:

Date:

Trace the missing letter A.

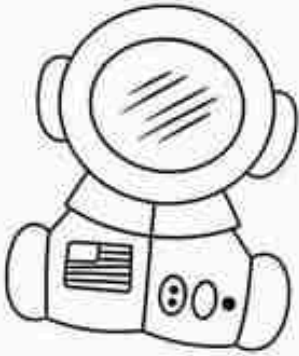

stronaut



ngel



pple

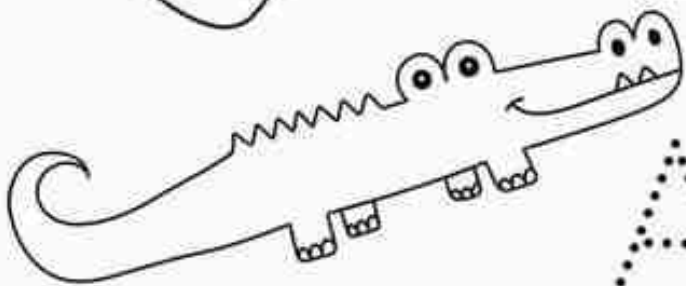

lligator



corn

Name:

Date:

Trace the missing letter B.



Bumble Bee



Boat



Balloon



Bird



Ballerina

Name:

Date:

Trace the missing letter C.



   upcake



   arrot

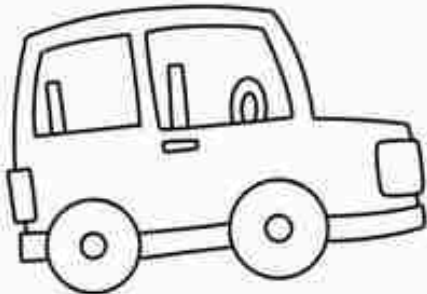

   ar



   astle

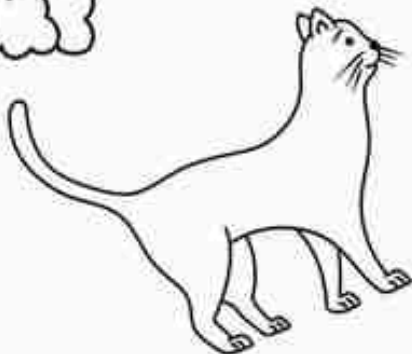

   at

Name:

Date:

Trace the missing letter D.



Donut



Duck



Drum



Dog



Dinosaur

Name:

Date:

Trace the missing letter E.

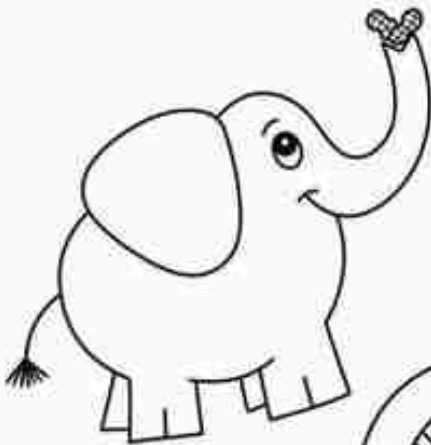

Elephant



Ear



Earth

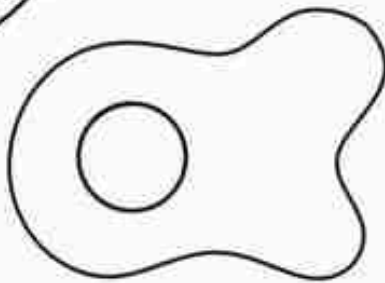

Egg

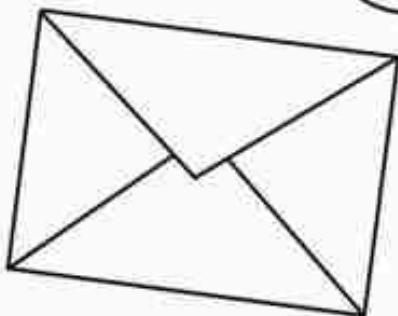

Envelope

Name:

Date:

Trace the missing letter F.

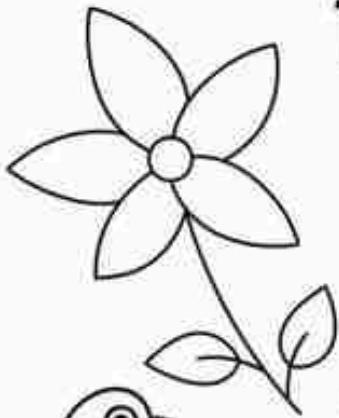

   F lower

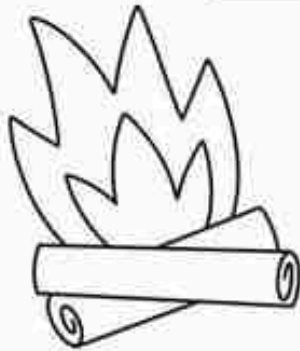

   F ire

   F lamingo

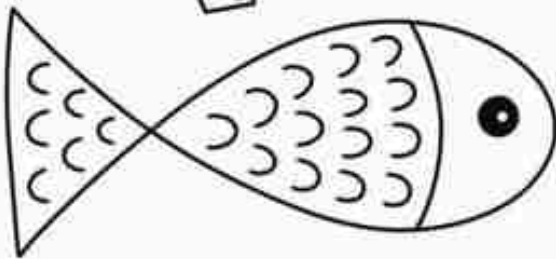

   F ish

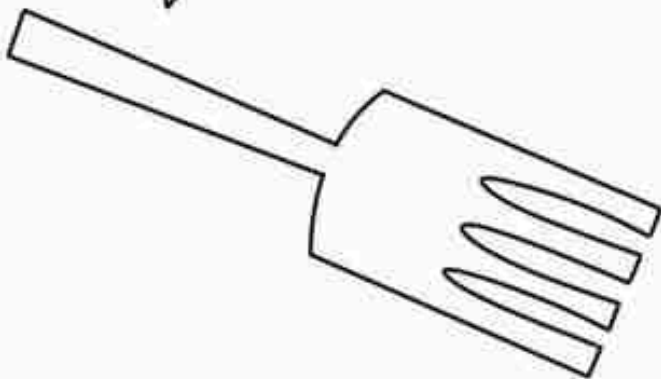

   F ork

Name:

Date:

Trace the missing letter G.



Goose

Ghost



Guitar



Grapes



Glasses

Name:

Date:

Trace the missing letter H.

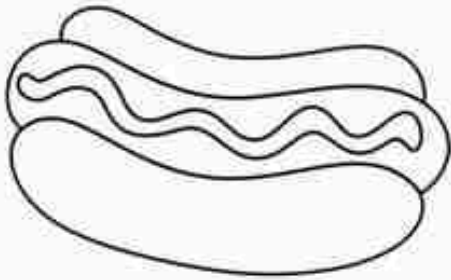

Hotdog

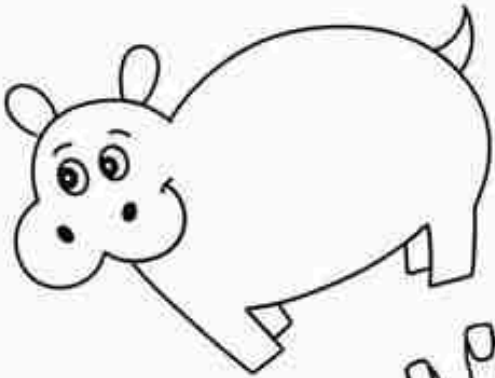

Hippo



Hand



Heart



Hat

Name:

Date:

Trace the missing letter I.



Ice-cream



Iguana



Island



Ink



Igloo

Name:

Date:

Trace the missing letter J.

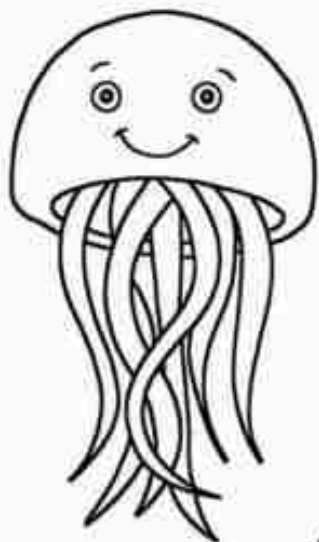

Jellyfish

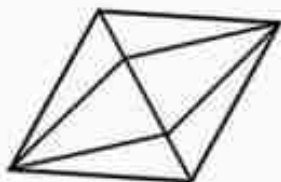

Jewel



Jump Rope



Juice



Jeans

Name:

Date:

Trace the missing letter K.



Kettle



King



Kangaroo

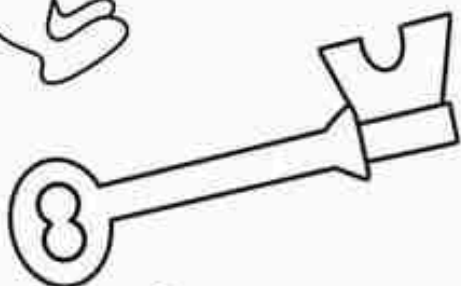

Key

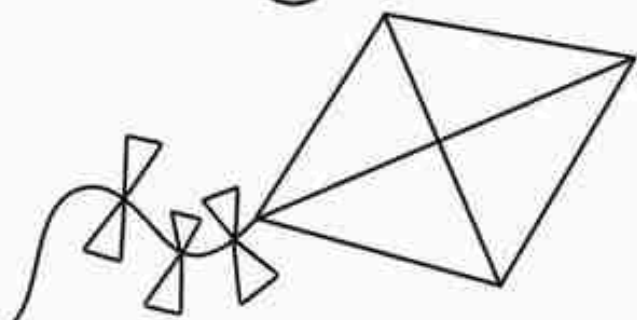

Kite

Name:

Date:

Trace the missing letter L.



Lion

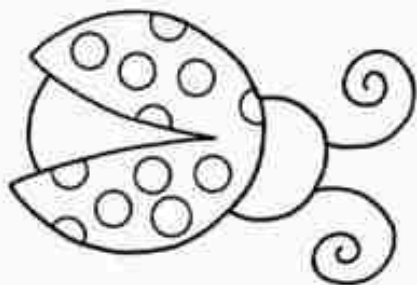

Ladybug



Leaf



Lollipop

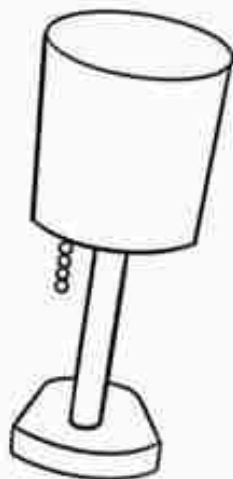

Lamp

Name:

Date:

Trace the missing letter M.



Music



Moon

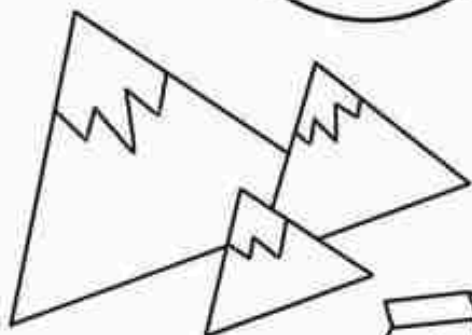

Mountains



Milk



Mitten

Name:

Date:

Trace the missing letter N.

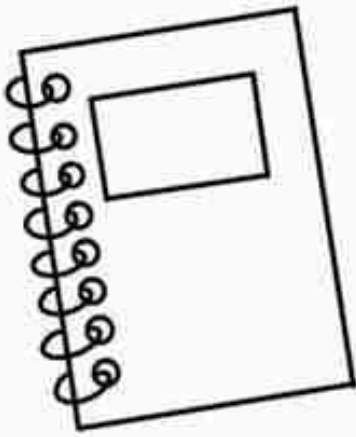

Notebook



Nose



Nest

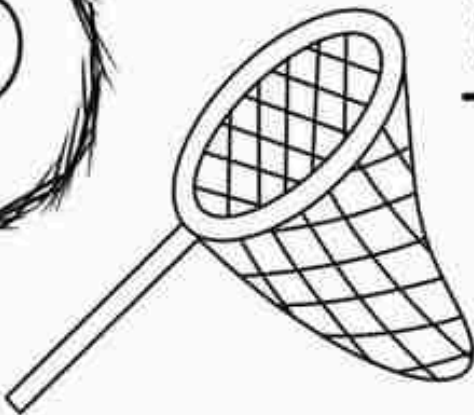

Net

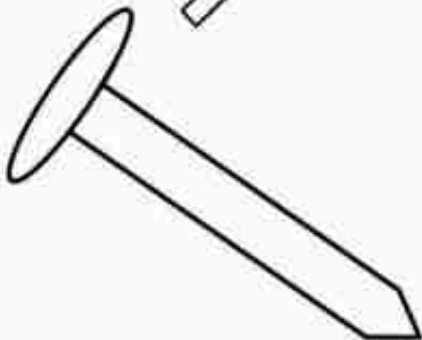

Nail

Name:

Date:

Trace the missing letter O.

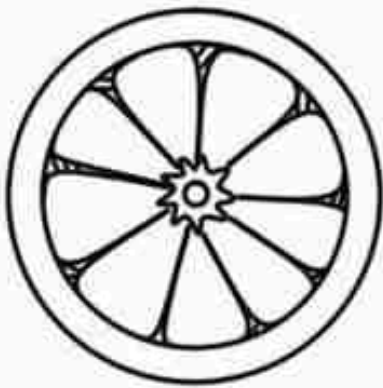

   orange



   owl

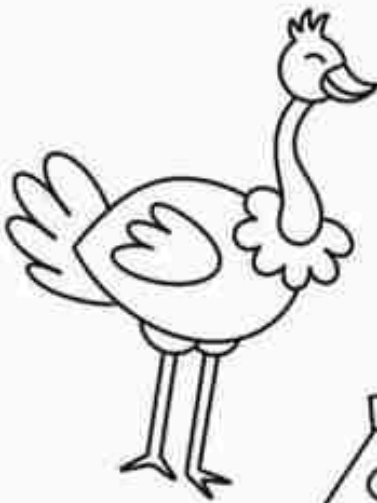

   ostrich

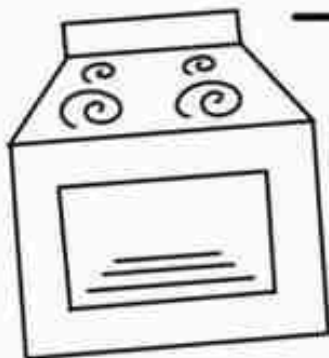

   oven



   octopus

Name:

Date:



Trace the missing letter P.

Pizza



Penguin

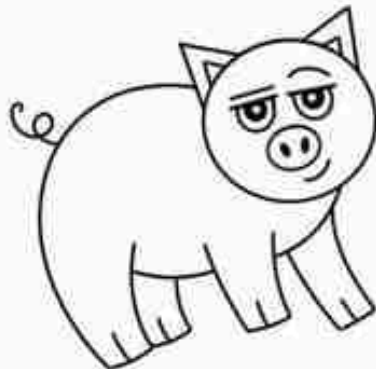

Pig



Plane



Pineapple

Name:

Date:

Trace the missing letter Q.



Queen

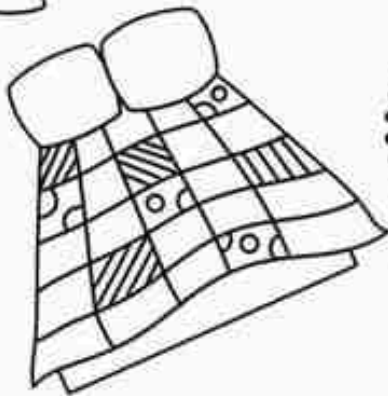

Quilt



Quiet

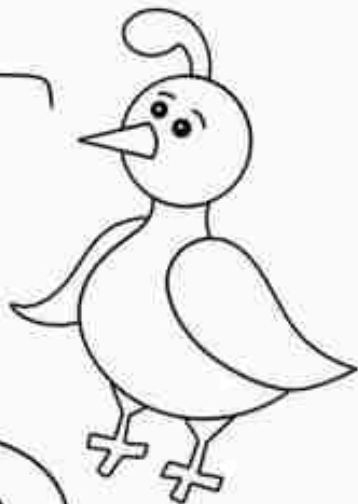

Quail



Question

Name:

Date:

Trace the missing letter R.

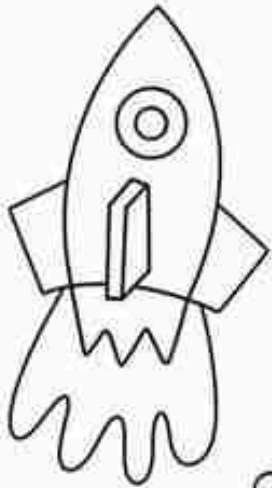

Rocket Ship

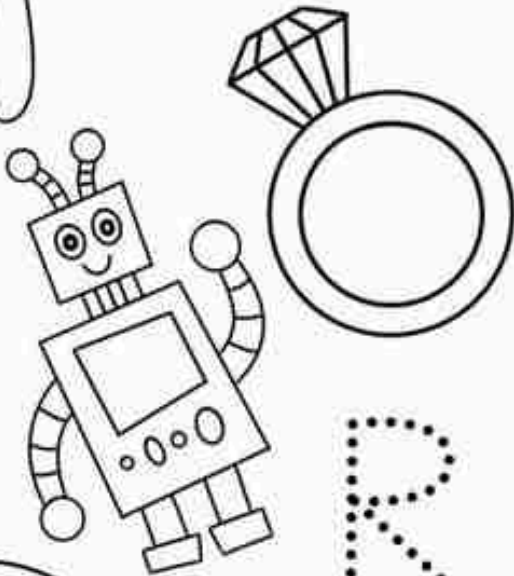

Ring

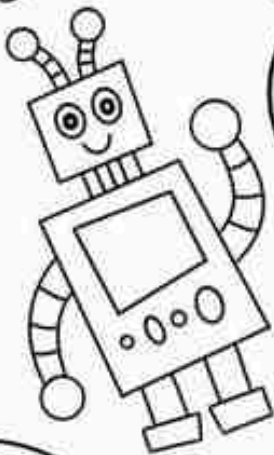

Robot



Rainbow



Rabbit

Name:

Date:

Trace the missing letter S.

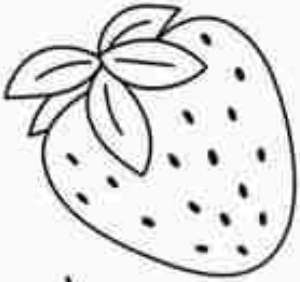

Strawberry

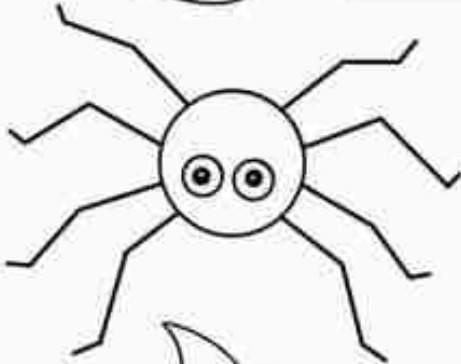

Spider

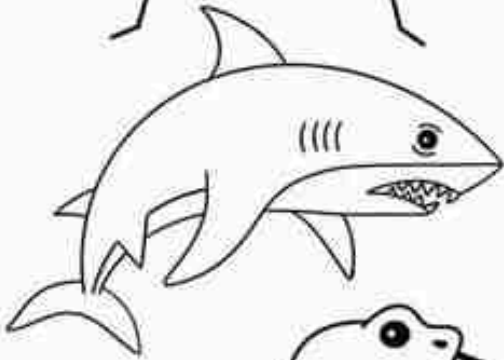

Shark



Snake



Star

Name:

Date:

Trace the missing letter T.

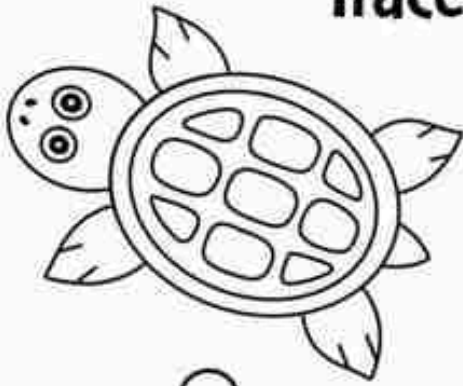

   Turtle



   Teapot

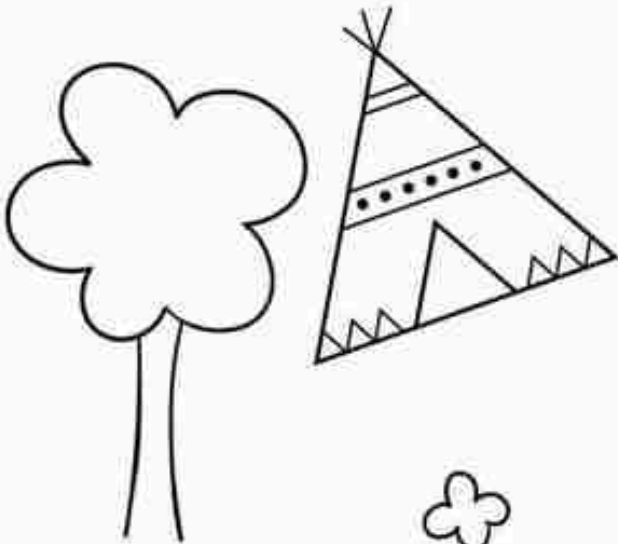

   Tent



   Tree

   Train

Name:

Date:

Trace the missing letter U.



Umbrella



Ukulele

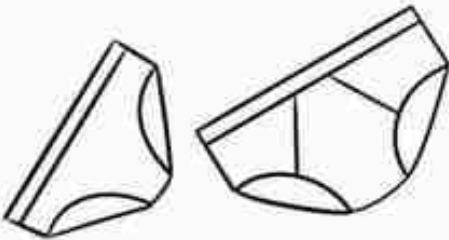

Underwear



Unicorn

Unicycle

Name:

Date:

Trace the missing letter V.



   olcano

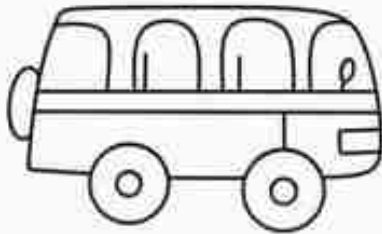

   an



   ase



   acuum



   est

Name:

Date:

Trace the missing letter W.

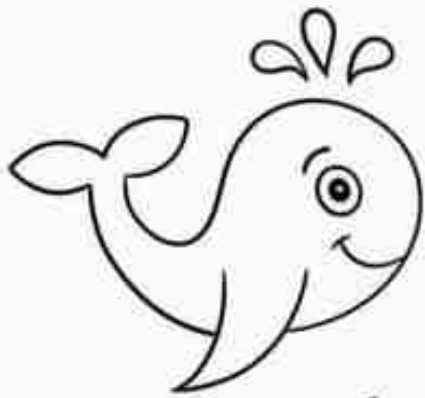

Whale



Watermelon



Worm

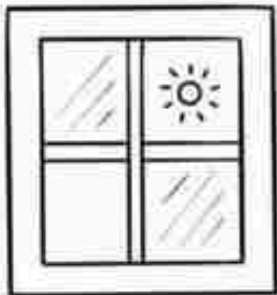

Window



Wagon

Name:

Date:

Trace the missing letter X.

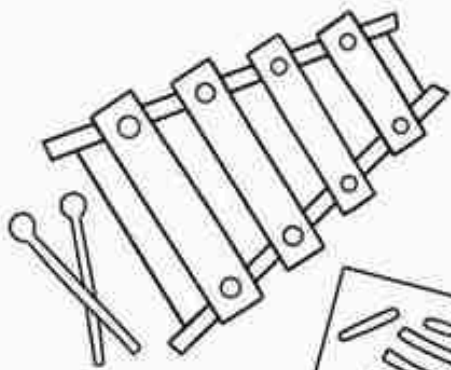

     X ylophone



     X -ray

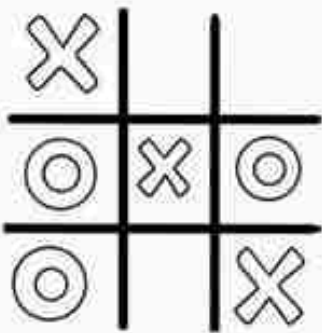

     X 's and O's

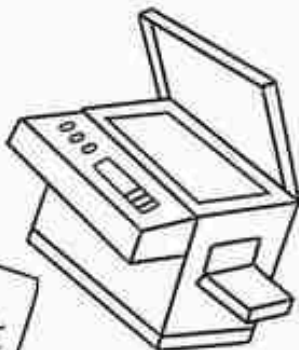

     Xerox

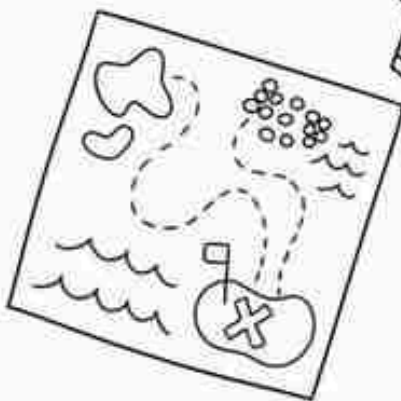

     X marks the spot!

Name:

Date:

Trace the missing letter Y.

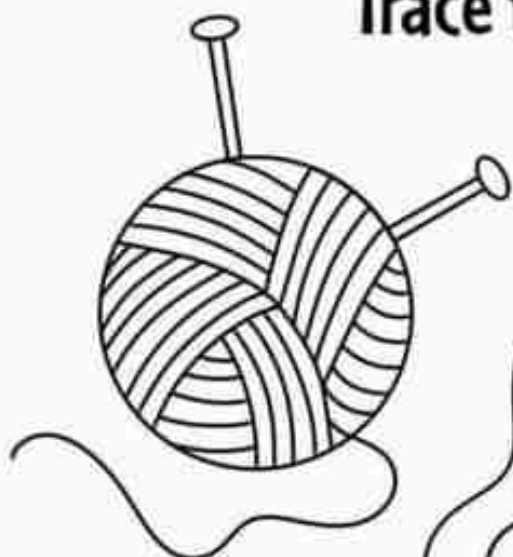

    Y     arn

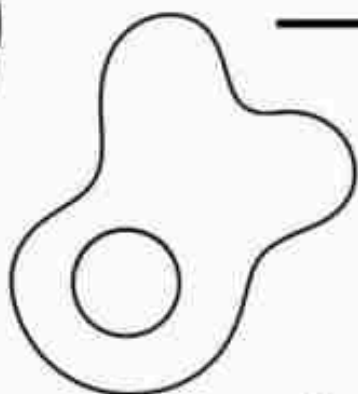

    Y     olk



    Y     ak



    Y     ogurt



    Y     o-yo

Name:

Date:

Trace the missing letter Z.

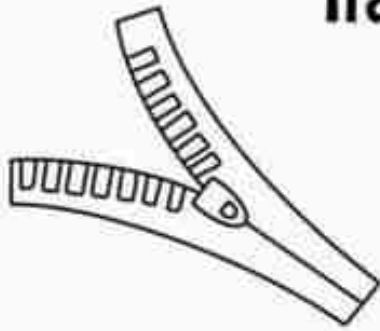

zipper

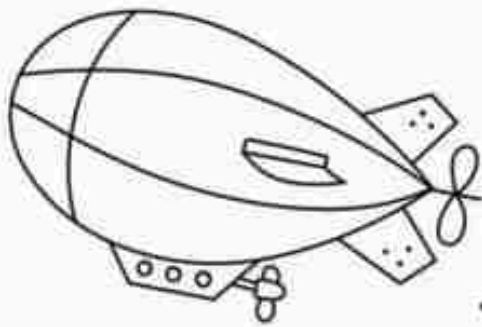

zeppelin



zucchini



zig-zag



zebra